

SPECTRALIS Imaging Platform Technical Specifications

The SPECTRALIS® is an ophthalmic imaging platform with an upgradeable and modular design. This flexible platform allows clinicians to configure each SPECTRALIS to the specific diagnostic workflow in the practice or clinic.

Setup and Dimensions

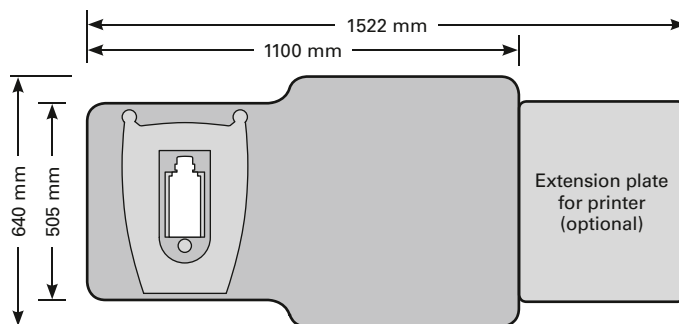

Note:
Table*, isolating transformer,
PC and monitor are available
as optional third-party hard-
ware but also provided by
Heidelberg Engineering.



*Alternative table configurations may be available in your country.

Core Technologies

The SPECTRALIS platform is based on 5 core technologies:

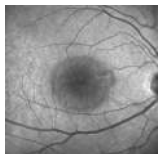

cSLO

The SPECTRALIS OCT uses confocal scanning laser ophthalmoscopy (cSLO) for fundus and anterior segment imaging. The confocal principle minimizes the effects of scattered light to produce high-contrast and detailed images. In many cases, a comprehensive assessment of the retina is possible even in patients with cataracts.



SD-OCT

Spectral domain optical coherence tomography (SD-OCT) provides high-resolution, two-dimensional OCT images of the retina and anterior segment. The next generation SD-OCT technology (OCT2) offers enhanced image quality from vitreous to choroid and faster image acquisition with a scanning speed of 85 kHz for improved clinical workflow.

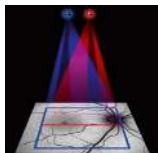

TruTrack Active Eye Tracking

TruTrack Active Eye Tracking is a patented technology that utilizes two laser scanning systems simultaneously to actively track the eye in real time throughout image acquisition. This mitigates the effects of eye motion, resulting in high-resolution OCT images. TruTrack is indispensable for the acquisition of high quality images throughout a volume scans.

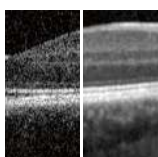

Noise Reduction

TruTrack Active Eye Tracking enables the capture of multiple OCT images in the exact same location. With these multiple images, SPECTRALIS noise reduction technology is able to differentiate structural information from noise, reducing noise even further and resulting in high contrast images.

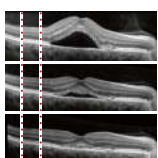

AutoRescan

With the AutoRescan function, follow-up examinations are automatically and precisely aligned with the fundus image of the reference examination using anatomic landmarks that allow for the detection of even very small pathologic changes over time. Studies have shown that the AutoRescan function offers reliable retinal thickness measurements as small as 1 micron.**

**Wolf-Schnurrbusch UE et al. - Macular Thickness Measurements in Healthy Eyes Using Six Different Optical Coherence Tomography Instruments. Invest Ophthalmol Vis Sci. 2009;50:3432-3437.

Multimodal Imaging

SPECTRALIS facilitates comprehensive diagnostics by combining multiple acquisition modes in a single device.



Infrared-Reflectance (IR)

With a wavelength of 815 nm, infrared reflectance allows for comfortable imaging and exact, high-resolution visualization of intraretinal changes, such as cystoid macular edema (CME) or central serous chorioretinopathy (CSCR).



Blue-Reflectance (red-free)

A blue laser with a wavelength of 486 nm is used for the acquisition of red-free fundus images. Blue reflectance images are best for spotting pathological changes in superficial retinal structures, such as epiretinal membranes, retinal folds, and cysts.



MultiColor

MultiColor simultaneously uses three laser wavelengths (infrared, green, and blue) to provide diagnostic images that show distinct structures at different depths within the retina. These detailed images enable visualization of structures and pathology not always visible on ophthalmoscopy or traditional fundus photography.

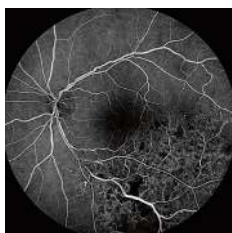

Scanning Laser Angiography

SPECTRALIS scanning laser angiography can be conducted with either fluorescein or ICG dye. Detailed, high-resolution images and video sequences visualize vessel filling, flow, and leakage. FA and ICGA can be acquired simultaneously or individually in combination with OCT imaging.

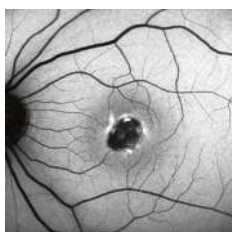

Fundus Autofluorescence (BluePeak)

BluePeak reveals metabolic stress in the retina using fluorescent lipofuscin as an indicator. With non-invasive fundus autofluorescence, areas of geographic atrophy and other pathologies can be easily visualized. The optional RegionFinder software allows for the quantification of atrophic areas in the retina seen on BluePeak images.

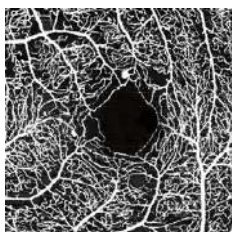

OCT Angiography (OCTA)

The OCT Angiography Module is a non-invasive imaging method that produces detailed three-dimensional representations of the retinal and choroidal vasculature. The multimodal SPECTRALIS platform offers the ability to combine OCTA with structural OCT, confocal scanning laser imaging, and dye-based angiography in a single device.

Technical Data

General Information

Input voltage	100 – 240 Volt
Power consumption	140 VA

Light Sources

FA laser	486 nm (blue)
Green laser	518 nm (green)
ICGA laser	786 nm (infrared)
IR laser	815 nm (infrared)
OCT-SLD	880 nm (infrared)

Standard Objective Lenses

Max. scan field (visual angle)	30° × 30° (ca. 9 × 9 mm)
ART (image averaging)	up to 100 single images

Widefield Imaging Objective Lens

Max. scan field (visual angle)	Ø 55° (ca. 16,5 mm)
High resolution mode (digital)	≈ 10 µm/pixel lateral
ART (image averaging)	up to 100 single images

Ultra-Widefield Imaging Objective Lens

Max. scan field	Ø 102° (ref. pupil), Ø 135° (ref. eye center)
High resolution mode (digital)	≈ 20 µm/pixel lateral
ART (image averaging)	up to 100 single images

OCT – Retinal imaging

A-scan rate	40 kHz / 85 kHz
Axial digital image size	496 pixel
Axial resolution	3,9 µm/pixel
Lateral resolution	5,7 µm/pixel
Scan angle	up to 55° (ca. 16,5 mm)
Scan depth into the tissue	1,9 mm
Scan patterns	Line scan, volume scan, radial scan, circle scan, ONH-RC scan, individual

OCT – Anterior imaging

cSLO image width	8,3 / 11 / 16,6 mm
OCT scan depth	8,3 / 11 / 16,6 mm
ART (image averaging)	up to 100 single images

OCT Angiography imaging

High speed mode	30° × 15° with 11 µm lateral resolution
High resolution mode	10° × 10° with 5,7 µm lateral resolution
Max. number of pixel	768 × 384 pixel
ART (image averaging)	up to 7 single images

Optional Modules*

As a modular platform, SPECTRALIS can be upgraded with the following modules:

- **OCT2 Module**
Improved acquisition speed and image quality with a scan rate of 85 kHz
- **OCT Angiography Module**
Non-invasive, three-dimensional imaging of retinal vascular flow
- **Glaucoma Module Premium Edition**
Comprehensive diagnostics combining an objective examination of the optic nerve head (ONH) with the analysis of the neuroretinal rim, retinal nerve fiber layer and ganglion cell layer
- **MultiColor Module**
Simultaneous scanning laser imaging with three laser wavelengths (infrared, green, and blue)
- **BluePeak Module**
Non-invasive fundus autofluorescence

Available Objective Lenses*

- **30° Standard Objective Lens**
Included as standard with every SPECTRALIS:
30° OCT and fundus imaging of all available modalities
- **Widefield Imaging Module**
55° widefield OCT and fundus imaging of all available modalities
- **Anterior Segment Module**
OCT imaging of the cornea, sclera, and anterior chamber angles
- **Ultra-Widefield Imaging Module**
102° (measured from the pupil) / 135° (measured from the eye center) fundus imaging (IR, FA, ICGA)



*Upgradeable modules depend on the existing SPECTRALIS model. Some modules can be ordered at initial purchase only.

Headquarters

Heidelberg Engineering GmbH
Max-Jarecki-Str. 8
69115 Heidelberg · Germany
Tel. +49 6221 64630

AUS

Heidelberg Engineering Pty Ltd
404 Albert St.
East Melbourne 3002 · Victoria
Tel. +61 396 392 125

CH

Heidelberg Engineering GmbH
Schulstrasse 161
8105 Regensdorf
Tel. +41 44 8887 020

UK

Heidelberg Engineering Ltd.
55 Marlowes · Hemel Hempstead
Hertfordshire HP1 1LE
Tel. +44 1442 502 330

**HEIDELBERG
ENGINEERING**

www.HeidelbergEngineering.com